



**MICROCHIP**

---

**UCS1001-3  
Evaluation Board  
User's Guide**

---

**Note the following details of the code protection feature on Microchip devices:**

- Microchip products meet the specification contained in their particular Microchip Data Sheet.
- Microchip believes that its family of products is one of the most secure families of its kind on the market today, when used in the intended manner and under normal conditions.
- There are dishonest and possibly illegal methods used to breach the code protection feature. All of these methods, to our knowledge, require using the Microchip products in a manner outside the operating specifications contained in Microchip's Data Sheets. Most likely, the person doing so is engaged in theft of intellectual property.
- Microchip is willing to work with the customer who is concerned about the integrity of their code.
- Neither Microchip nor any other semiconductor manufacturer can guarantee the security of their code. Code protection does not mean that we are guaranteeing the product as "unbreakable."

Code protection is constantly evolving. We at Microchip are committed to continuously improving the code protection features of our products. Attempts to break Microchip's code protection feature may be a violation of the Digital Millennium Copyright Act. If such acts allow unauthorized access to your software or other copyrighted work, you may have a right to sue for relief under that Act.

---

Information contained in this publication regarding device applications and the like is provided only for your convenience and may be superseded by updates. It is your responsibility to ensure that your application meets with your specifications. MICROCHIP MAKES NO REPRESENTATIONS OR WARRANTIES OF ANY KIND WHETHER EXPRESS OR IMPLIED, WRITTEN OR ORAL, STATUTORY OR OTHERWISE, RELATED TO THE INFORMATION, INCLUDING BUT NOT LIMITED TO ITS CONDITION, QUALITY, PERFORMANCE, MERCHANTABILITY OR FITNESS FOR PURPOSE. Microchip disclaims all liability arising from this information and its use. Use of Microchip devices in life support and/or safety applications is entirely at the buyer's risk, and the buyer agrees to defend, indemnify and hold harmless Microchip from any and all damages, claims, suits, or expenses resulting from such use. No licenses are conveyed, implicitly or otherwise, under any Microchip intellectual property rights.

**Trademarks**

The Microchip name and logo, the Microchip logo, dsPIC, FlashFlex, KEELOQ, KEELOQ logo, MPLAB, PIC, PICmicro, PICSTART, PIC<sup>32</sup> logo, rPIC, SST, SST Logo, SuperFlash and UNI/O are registered trademarks of Microchip Technology Incorporated in the U.S.A. and other countries.

FilterLab, Hampshire, HI-TECH C, Linear Active Thermistor, MTP, SEEVAL and The Embedded Control Solutions Company are registered trademarks of Microchip Technology Incorporated in the U.S.A.

Silicon Storage Technology is a registered trademark of Microchip Technology Inc. in other countries.

Analog-for-the-Digital Age, Application Maestro, BodyCom, chipKIT, chipKIT logo, CodeGuard, dsPICDEM, dsPICDEM.net, dsPICworks, dsSPEAK, ECAN, ECONOMONITOR, FanSense, HI-TIDE, In-Circuit Serial Programming, ICSP, Mindi, MiWi, MPASM, MPF, MPLAB Certified logo, MPLIB, MPLINK, mTouch, Omniscent Code Generation, PICC, PICC-18, PICDEM, PICDEM.net, PICkit, PICtail, REAL ICE, rLAB, Select Mode, SQI, Serial Quad I/O, Total Endurance, TSHARC, UniWinDriver, WiperLock, ZENA and Z-Scale are trademarks of Microchip Technology Incorporated in the U.S.A. and other countries.

SQTP is a service mark of Microchip Technology Incorporated in the U.S.A.

GestIC and ULPP are registered trademarks of Microchip Technology Germany II GmbH & Co. KG, a subsidiary of Microchip Technology Inc., in other countries.

All other trademarks mentioned herein are property of their respective companies.

© 2013, Microchip Technology Incorporated, Printed in the U.S.A., All Rights Reserved.

 Printed on recycled paper.

ISBN: 978-1-62077-625-4

**QUALITY MANAGEMENT SYSTEM  
CERTIFIED BY DNV  
= ISO/TS 16949 =**

*Microchip received ISO/TS-16949:2009 certification for its worldwide headquarters, design and wafer fabrication facilities in Chandler and Tempe, Arizona; Gresham, Oregon and design centers in California and India. The Company's quality system processes and procedures are for its PIC<sup>®</sup> MCUs and dsPIC<sup>®</sup> DSCs, KEELOQ<sup>®</sup> code hopping devices, Serial EEPROMs, microperipherals, nonvolatile memory and analog products. In addition, Microchip's quality system for the design and manufacture of development systems is ISO 9001:2000 certified.*

**Table of Contents**

<b>Preface</b> .....	<b>7</b>
Introduction.....	7
Document Layout .....	7
Conventions Used in this Guide .....	8
Recommended Reading.....	9
The Microchip Web Site .....	9
Customer Support .....	9
Document Revision History .....	9
 <b>Chapter 1. Product Overview</b>	
1.1 Introduction .....	11
1.2 Evaluation System Features .....	11
1.2.1 Board Component Location .....	12
1.3 What the UCS1001-3 Evaluation Board Kit Contains .....	12
 <b>Chapter 2. Installation and Operation</b>	
2.1 Getting Started .....	13
2.1.1 System Requirements .....	13
2.1.2 Evaluation Board Jumper Configuration .....	13
2.1.3 Configuration for Dedicated Charger Emulation (DCE) Mode .....	14
2.1.4 Configuration for BC1.2 CDP Mode .....	15
2.1.5 Configuration for BC1.2 DCP Mode .....	15
2.1.6 Configuration for BC1.2 SDP Mode .....	16
 <b>Chapter 3. Hardware Overview</b>	
3.1 Introduction .....	17
3.1.1 Power Source .....	17
3.2 Stand-Alone Functionality .....	17
3.2.1 Charger Emulation Mode Configurations .....	17
3.2.2 Attach Detection and Power States .....	17
3.3 Fault Handling .....	17
3.4 Current Limiting .....	17
3.5 High-Speed USB Data Switch .....	17
 <b>Appendix A. Schematics and Layouts</b>	
A.1 Introduction .....	19
A.2 Board – Schematic .....	20
A.3 Board – Top Silk .....	21
A.4 Board – Top Silk and Pads .....	21
A.5 Board – Top Silk and Copper .....	22

# UCS1001-3 Evaluation Board User's Guide

---

A.6 Board – Top Copper .....	22
A.7 Board – Bottom Copper .....	23
A.8 Board – Bottom Silk and Copper .....	23
A.9 Board – Bottom Silk and Pads .....	24
A.10 Board – Bottom Silk .....	24
<b>Appendix B. Bill of Materials (BOM)</b>	
<b>Worldwide Sales and Service .....</b>	<b>27</b>

---

---

**Object of Declaration: UCS1001-3 Evaluation Board User's Guide**

EU Declaration of Conformity

This declaration of conformity is issued by the manufacturer.

The development/evaluation tool is designed to be used for research and development in a laboratory environment. This development/evaluation tool is not a Finished Appliance, nor is it intended for incorporation into Finished Appliances that are made commercially available as single functional units to end users under EU EMC Directive 2004/108/EC and as supported by the European Commission's Guide for the EMC Directive 2004/108/EC (8<sup>th</sup> February 2010).

This development/evaluation tool complies with EU RoHS2 Directive 2011/65/EU.

For information regarding the exclusive, limited warranties applicable to Microchip products, please see Microchip's standard terms and conditions of sale, which are printed on our sales documentation and available at [www.microchip.com](http://www.microchip.com).

Signed for and on behalf of Microchip Technology Inc. at Chandler, Arizona, USA

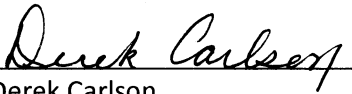

Derek Carlson

VP Development Tools

16-July-2013

Date

# UCS1001-3 Evaluation Board User's Guide

---

NOTES:

---

---

## Preface

---

---

### NOTICE TO CUSTOMERS

All documentation becomes dated, and this manual is no exception. Microchip tools and documentation are constantly evolving to meet customer needs, so some actual dialogs and/or tool descriptions may differ from those in this document. Please refer to our web site ([www.microchip.com](http://www.microchip.com)) to obtain the latest documentation available.

Documents are identified with a “DS” number. This number is located on the bottom of each page, in front of the page number. The numbering convention for the DS number is “DSXXXXA”, where “XXXX” is the document number and “A” is the revision level of the document.

For the most up-to-date information on development tools, see the MPLAB® IDE online help. Select the Help menu, and then Topics to open a list of available online help files.

## INTRODUCTION

This chapter contains general information that will be useful to know before using the UCS1001-3. Items discussed in this chapter include:

- Document Layout
- Conventions Used in this Guide
- Recommended Reading
- The Microchip Web Site
- Customer Support
- Document Revision History

## DOCUMENT LAYOUT

This document describes how to use the UCS1001-3 as a development tool to emulate and debug firmware on a target board. The manual layout is as follows:

- **Chapter 1. “Product Overview”** – Important information about the UCS1001-3 Evaluation Board.
- **Chapter 2. “Installation and Operation”** – Includes instructions on installing and getting started with the UCS1001-3 Evaluation Board.
- **Chapter 3. “Hardware Overview”** – Shows hardware details of the UCS1001-3 Evaluation Board.
- **Appendix A. “Schematics and Layouts”** – Shows the schematic and layout diagrams for the UCS1001-3 Evaluation Board.
- **Appendix B. “Bill of Materials (BOM)”** – Lists the parts used to build the UCS1001-3 Evaluation Board.

# UCS1001-3 Evaluation Board User's Guide

---

## CONVENTIONS USED IN THIS GUIDE

This manual uses the following documentation conventions:

### DOCUMENTATION CONVENTIONS

Description	Represents	Examples
<b>Arial font:</b>		
Italic characters	Referenced books	<i>MPLAB<sup>®</sup> IDE User's Guide</i>
	Emphasized text	...is the <i>only</i> compiler...
Initial caps	A window	the Output window
	A dialog	the Settings dialog
	A menu selection	select Enable Programmer
Quotes	A field name in a window or dialog	"Save project before build"
Underlined, italic text with right angle bracket	A menu path	<u><i>File&gt;Save</i></u>
Bold characters	A dialog button	Click <b>OK</b>
	A tab	Click the <b>Power</b> tab
N'Rnnnn	A number in verilog format, where N is the total number of digits, R is the radix and n is a digit.	4'b0010, 2'hF1
Text in angle brackets < >	A key on the keyboard	Press <Enter>, <F1>
<b>Courier New font:</b>		
Plain Courier New	Sample source code	#define START
	Filenames	autoexec.bat
	File paths	c:\mcc18\h
	Keywords	_asm, _endasm, static
	Command-line options	-Opa+, -Opa-
	Bit values	0, 1
	Constants	0xFF, 'A'
Italic Courier New	A variable argument	<i>file.o</i> , where <i>file</i> can be any valid filename
Square brackets [ ]	Optional arguments	mcc18 [options] <i>file</i> [options]
Curly brackets and pipe character: {   }	Choice of mutually exclusive arguments; an OR selection	errorlevel {0 1}
Ellipses...	Replaces repeated text	var_name [, var_name...]
	Represents code supplied by user	void main (void) { ... }



## RECOMMENDED READING

This user's guide describes how to use UCS1001-3. Other useful documents are listed below. The following Microchip documents are available and recommended as supplemental reference resources.

- **UCS1001-3 Data Sheet – “USB Port Power Controller with Charger Emulation” (Revision 1.4 – 07-16-13)**
- **AN 24.20 – “Using the UCS100x as a Single or Dual Mode Charger” (Revision 1.0)**
- **AN 25.16 – “USB Charging Port ESD Protection Tips for UCS100x” (Revision 1.0)**
- **AN 26.0 – “UCS1001 Current Limit Operation and Features” (Revision 1.1)**

## THE MICROCHIP WEB SITE

Microchip provides online support via our web site at [www.microchip.com](http://www.microchip.com). This web site is used as a means to make files and information easily available to customers. Accessible by using your favorite Internet browser, the web site contains the following information:

- **Product Support** – Data sheets and errata, application notes and sample programs, design resources, user's guides and hardware support documents, latest software releases and archived software
- **General Technical Support** – Frequently Asked Questions (FAQs), technical support requests, online discussion groups, Microchip consultant program member listing
- **Business of Microchip** – Product selector and ordering guides, latest Microchip press releases, listing of seminars and events, listings of Microchip sales offices, distributors and factory representatives

## CUSTOMER SUPPORT

Users of Microchip products can receive assistance through several channels:

- Distributor or Representative
- Local Sales Office
- Field Application Engineer (FAE)
- Technical Support

Customers should contact their distributor, representative or field application engineer (FAE) for support. Local sales offices are also available to help customers. A listing of sales offices and locations is included in the back of this document.

Technical support is available through the web site at:  
<http://www.microchip.com/support>.

## DOCUMENT REVISION HISTORY

### Revision A (November 2013)

- Initial Release of this Document.

# UCS1001-3 Evaluation Board User's Guide

---

NOTES:

## Chapter 1. Product Overview

### 1.1 INTRODUCTION

The UCS1001-3 device is a Universal Serial Bus (USB) port power switch with charger emulation. All of the functions of the UCS1001-3 device can be tested and observed with the UCS1001-3 Evaluation Board. A block diagram of this evaluation board Charger Emulation Test Set Up is shown in Figure 1-1.

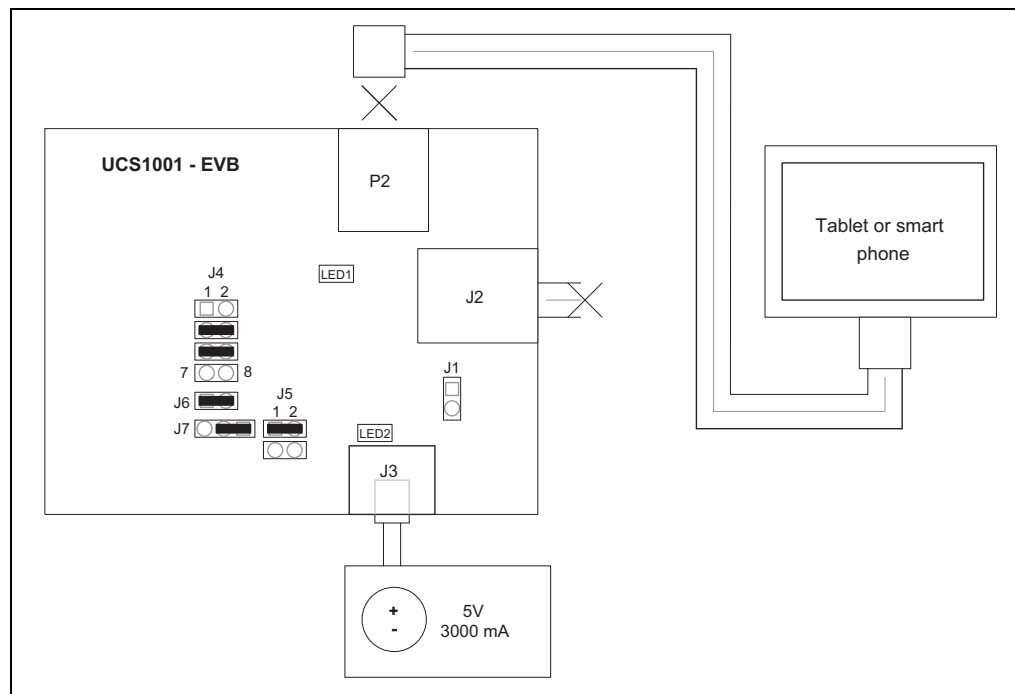

**FIGURE 1-1:** UCS1001-3 Evaluation Board – Charger Emulation Test Set Up Block Diagram.

### 1.2 EVALUATION SYSTEM FEATURES

The evaluation setup is comprised of the UCS1001-3 Evaluation Board and a downstream tablet or cell phone device, which allows the user to:

- Observe the Charger Emulation functionality
- Observe the BC1.2 Charging Downstream Port (CDP), Dedicated Charging Port (DCP) and Standard Downstream Port (SDP) functionality
- Observe the USB Pass-Through functionality

The hardware platform provides the following features to the user:

- Jumpers for modes of operation: Dedicated Charger Emulation (DCE), DCP, CDP and USB Pass-Through
- Jumper for Fault Handling: Latch upon fault, or Auto-recovery
- Jumper for Current Limiting of 2.5 or 0.5A
- Jumper for PWR\_EN

# UCS1001-3 Evaluation Board User's Guide

## 1.2.1 Board Component Location

The evaluation board was designed for ease of use and user experimentation. Figure 1-2 below shows the top-printed circuit board 3D plot for the UCS1001-3 Evaluation Board.

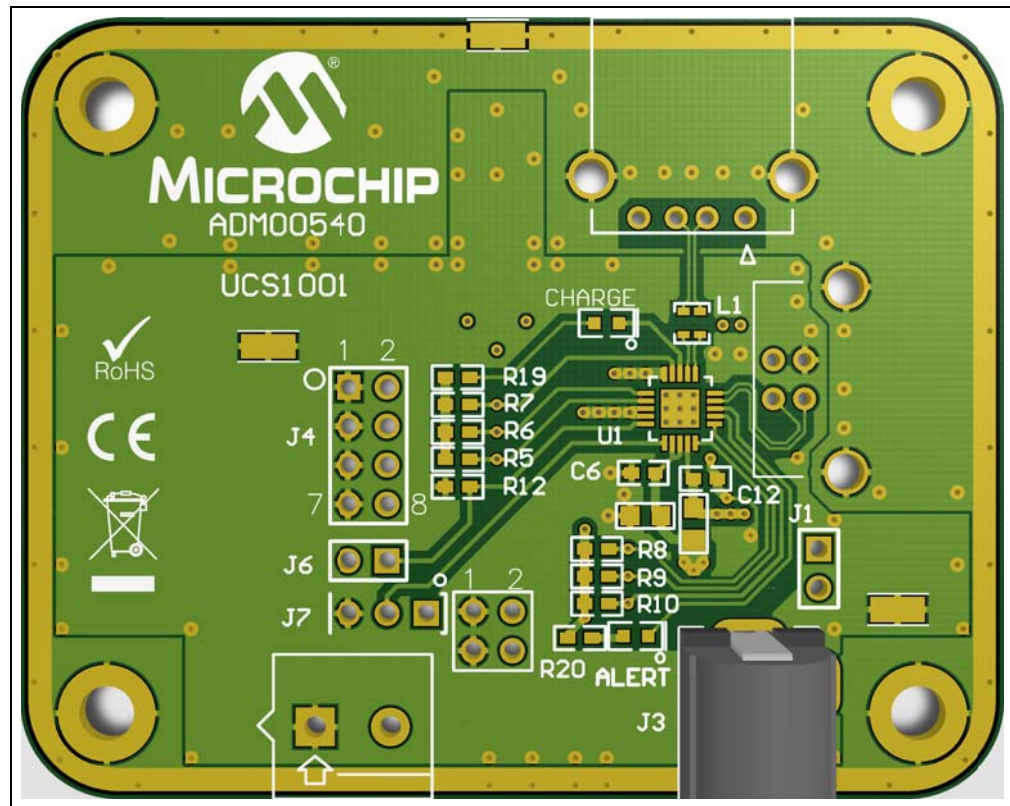

**FIGURE 1-2:** UCS1001-3 Evaluation Board – Top 3D View.

## 1.3 WHAT THE UCS1001-3 EVALUATION BOARD KIT CONTAINS

This UCS1001-3 Evaluation Board kit includes:

- UCS1001-3 Evaluation Board (ADM00540)
- Provided 20W, 5V wall power adapter
- Important Information Sheet

## Chapter 2. Installation and Operation

### 2.1 GETTING STARTED

#### 2.1.1 System Requirements

To use the UCS1001-3 Evaluation Board, the following are required:

- A 5V supply capable of 5V, 3.0A, or the wall transformer provided in the evaluation kit.
- Various downstream USB devices to charge, such as tablets and cell phones.
- A PC with an USB port to demonstrate CDP, SDP or USB Enumeration.

#### 2.1.2 Evaluation Board Jumper Configuration

Table 2-1 describes each jumper setting used with this evaluation board. Refer to Figure 2-1 for the jumper location.

**TABLE 2-1: UCS1001-3 EVB JUMPER DESCRIPTION**

Jumper Designator	Pin Name	Function Description
J4: 1-2	EM_EN	Jumper placed = Logic Low
J4: 3-4	M1	
J4: 5-6	M2	
J4: 7-8	PWR_EN	
J6: 1-2	ILIM	Jumper placed = Logic High: 2.5A Current Limit Jumper open = 47K Pull Down: 0.5A Current Limit
J7: 1-2	SEL	Jumper placed = Logic High: PWR_EN is Active High
J7: 2-3		Jumper placed = Logic Low: PWR_EN is Active Low
J5: 1-2	LATCH	Jumper placed = Logic Low: LATCH = 0, Auto-recovery enabled Jumper open = Logic High: LATCH = 1, Auto-recovery disabled
J5: 3-4	S0	Jumper placed = Logic Low: S0 = 0, Active mode Jumper open = Logic High: S0 = 1, Detect mode
J1: 1-2	USB Power	This jumper is to be left OPEN so that V <sub>DD</sub> and V <sub>SOURCE</sub> can be sourced from J3.
J3	V <sub>DD</sub> and V <sub>S</sub>	Power supply for V <sub>DD</sub> and V <sub>SOURCE</sub>
J8	Not Used	Not populated. Optional for Split Rail supply use.
J2	USB-B	USB port for Host PC
P2	USB-A	USB port for Downstream Device

# UCS1001-3 Evaluation Board User's Guide

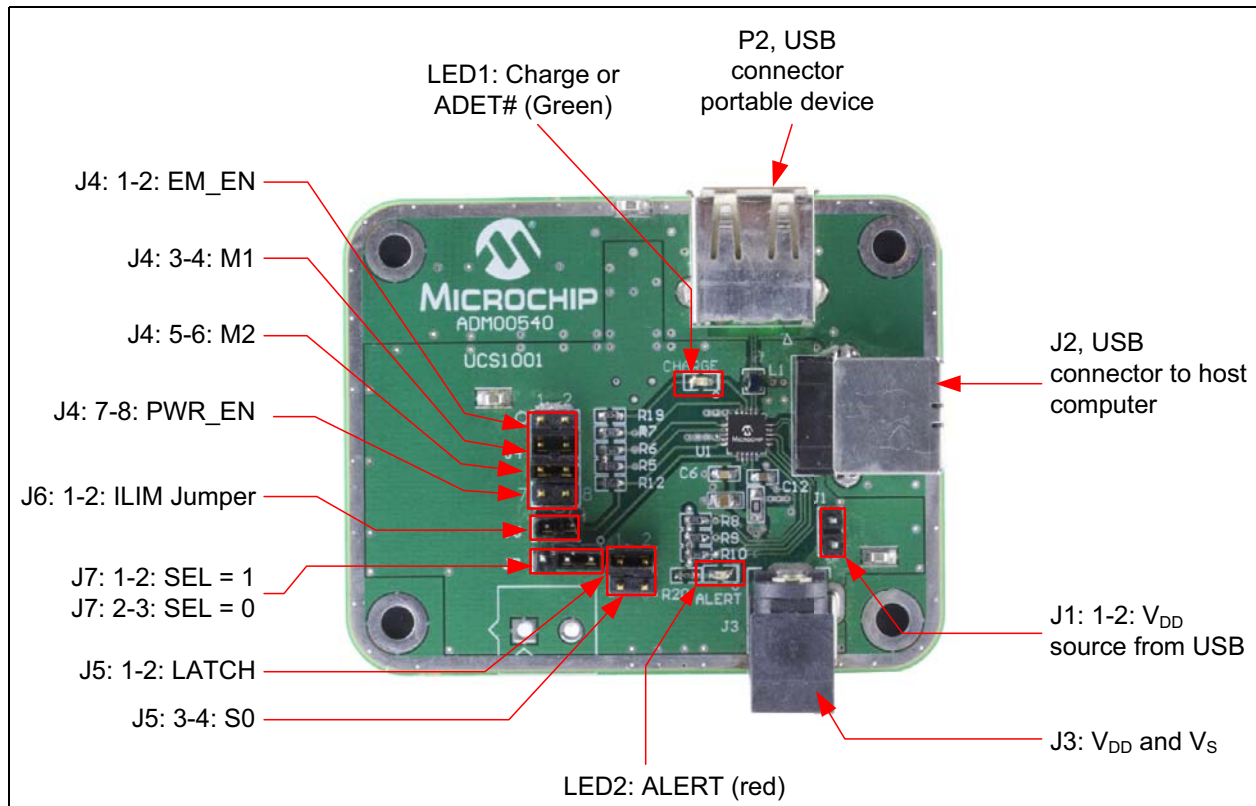

**FIGURE 2-1:** UCS1001-3 Evaluation Board Jumper Location.

## 2.1.3 Configuration for Dedicated Charger Emulation (DCE) Mode

The Dedicated Charger Emulation (DCE) mode configures the UCS1001-3 Evaluation Board to cycle through emulation profiles until  $I_{BUS\_CHG}$  increases above the threshold of 156 mA. To configure the evaluation board for DCE:

1. Configure the jumper settings as shown in Table 2-2.
2. Apply 5V to J3.
3. The UCS1001-3 is set for the DETECT state and awaits a downstream device attachment.

Connect a tablet or a cell phone to the USB port P2. When a Charger Emulation Profile is applied and  $I_{BUS\_CHG}$  increases above 156 mA, LED1 will illuminate and charging will continue.

**TABLE 2-2: UCS1001-3 EVALUATION BOARD JUMPER SETTINGS FOR DCE MODE**

Jumper Designator	Pin Name	Function Description
J4: 1-2	EM_EN	OPEN: Logic High
J4: 3-4	M1	SHORT: Logic Low
J4: 5-6	M2	SHORT: Logic Low
J4: 7-8	PWR_EN	OPEN: Logic High
J6: 1-2	ILIM	SHORT: Logic High – 2.5A Current Limit
J7: 1-2	SEL	SHORT: Logic High – PWR_EN is Active High
J5: 1-2	LATCH	SHORT: Logic Low – LATCH = 0, Auto-recovery enabled
J5: 3-4	S0	OPEN: Logic High – S0 = 1, Detect mode

## 2.1.4 Configuration for BC1.2 CDP mode

The Charging Downstream Port (CDP) mode configures the UCS1001-3 Evaluation Board to Handshake response, Enumerate the USB, and charge the downstream device. To configure the evaluation board for CDP:

1. Configure the jumper settings as shown in Table 2-3.
2. Apply 5V to J3.
3. Connect the EVB J2 (USB-B) to an Upstream PC USB port.
4. The UCS1001-3 is set for ACTIVE state and awaits a downstream device to provide Handshake stimulus on the DP pin upon attachment.

**TABLE 2-3: UCS1001-3 EVALUATION BOARD JUMPER SETTINGS FOR CDP MODE**

Jumper Designator	Pin Name	Function Description
J4: 1-2	EM_EN	OPEN: Logic High
J4: 3-4	M1	OPEN: Logic High
J4: 5-6	M2	OPEN: Logic High
J4: 7-8	PWR_EN	OPEN: Logic High
J6: 1-2	ILIM	SHORT: Logic High – 2.5A Current Limit
J7: 1-2	SEL	SHORT: Logic High – PWR_EN is Active High
J5: 1-2	LATCH	SHORT: Logic Low – LATCH = 0, Auto-recovery enabled
J5: 3-4	S0	SHORT: Logic Low – S0 = 0, Active mode

Connect a BC1.2-compliant device to the USB Port P2. Once the handshaking response and stimulus are complete, the USB will Enumerate and the downstream device will charge.

## 2.1.5 Configuration for BC1.2 DCP mode

The Dedicated Charging Port (DCP) mode configures the UCS1001-3 Evaluation Board to Handshake respond and charge the downstream device. The DCP is similar to the Chinese Telecommunications Industry Standard YD/T 1591-2009. To configure the evaluation board for DCP:

1. Configure the jumper settings as shown in Table 2-4.
2. Apply 5V to J3.
3. The UCS1001-3 is set for ACTIVE state and awaits a downstream device to Handshake upon attachment.

**TABLE 2-4: UCS1001-3 EVALUATION BOARD JUMPER SETTINGS FOR DCP MODE**

Jumper Designator	Pin Name	Function Description
J4: 1-2	EM_EN	OPEN: Logic High
J4: 3-4	M1	SHORT: Logic Low
J4: 5-6	M2	OPEN: Logic High
J4: 7-8	PWR_EN	OPEN: Logic High
J6: 1-2	ILIM	SHORT: Logic High – 2.5A Current Limit
J7: 1-2	SEL	SHORT: Logic High – PWR_EN is Active High
J5: 1-2	LATCH	SHORT: Logic Low – LATCH = 0, Auto-recovery enabled
J5: 3-4	S0	SHORT: Logic Low – S0 = 0, Active mode

# UCS1001-3 Evaluation Board User's Guide

---

## 2.1.6 Configuration for BC1.2 SDP mode

The Standard Downstream Port (SDP) mode configures the UCS1001-3 Evaluation Board to close the High-Speed Switch and allow the USB to Enumerate. To configure the evaluation board for SDP:

1. Configure the Jumper settings as shown in Table 2-5 below.
2. Apply 5V to J3.
3. Connect the evaluation board J2 (USB-B) to an upstream PC USB port.
4. The UCS1001-3 is set for ACTIVE state and awaits a downstream device to Enumerate the USB upon attachment.

**TABLE 2-5: UCS1001-3 EVALUATION BOARD JUMPER SETTINGS FOR SDP MODE**

Jumper Designator	Pin Name	Function Description
J4: 1-2	EM_EN	SHORT: Logic Low
J4: 3-4	M1	OPEN: Logic High
J4: 5-6	M2	SHORT: Logic Low
J4: 7-8	PWR_EN	OPEN: Logic High
J6: 1-2	ILIM	SHORT: Logic High – 2.5A Current Limit
J7: 1-2	SEL	SHORT: Logic High – PWR_EN is Active High
J5: 1-2	LATCH	SHORT: Logic Low – LATCH = 0, Auto-recovery enabled
J5: 3-4	S0	SHORT: Logic Low – S0 = 0, Active mode



---

---

## Chapter 3. Hardware Overview

---

---

### 3.1 INTRODUCTION

The UCS1001-3 Evaluation Board provides the means to demonstrate all of the UCS1001-3 functionality. The LEDs indicate the status information.

#### 3.1.1 Power Source

The UCS1001-3 Evaluation Board requires 5V, 3.0A.

### 3.2 STAND-ALONE FUNCTIONALITY

The UCS1001-3 is intended for Stand-Alone USB Charger and BC1.2 CDP, DCP and SDP applications. See Table 2-1 for the description of jumpers.

LED1 indicates that the  $I_{BUS\_CHG}$  has exceeded the 156 mA threshold.

#### 3.2.1 Charger Emulation Mode Configurations

The Charger Emulation mode of the UCS1001-3 is controlled by the pin states M1, M2 and EM\_EN. These are the jumpers located on J4.

#### 3.2.2 Attach Detection and Power States

The UCS1001-3 can use the Attach Detection functionality, or force the Active Mode Power State. This is controlled by jumper J5.

### 3.3 FAULT HANDLING

The UCS1001-3 has two modes of Fault Handling that can be configured for LATCH upon fault or Auto-recovery. Jumper J5 selects the Fault Handling. See Table 2-1 for the description of jumpers.

### 3.4 CURRENT LIMITING

The UCS1001-3 is capable of eight selectable current limits (see UCS1001-3's data sheet for detailed information).

The UCS1001-3 Evaluation Board can be configured for MAX (2.5A) or MIN (0.5A) Current Limiting. Jumper J6 selects the MIN or MAX Current Limiting. See Table 2-1 for the description of jumpers.

### 3.5 HIGH SPEED USB DATA SWITCH

The UCS1001-3 contains a series USB 2.0-compliant high-speed switch between the DP and DM input and output pins. This switch is functional in CDP, SDP and Pass-through configurations.

# UCS1001-3 Evaluation Board User's Guide

---

NOTES:



# UCS1001-3 EVALUATION BOARD USER'S GUIDE

---

---

## Appendix A. Schematics and Layouts

---

---

### A.1 INTRODUCTION

This appendix contains the following schematics and layouts for the UCS1001-3 Evaluation Board:

- Board – Schematic
- Board – Top Silk
- Board – Top Silk and Pads
- Board – Top Silk and Copper
- Board – Top Copper
- Board – Bottom Copper
- Board – Bottom Silk and Copper
- Board – Bottom Silk and Pads
- Board – Bottom Silk

## A.2 BOARD – SCHEMATIC

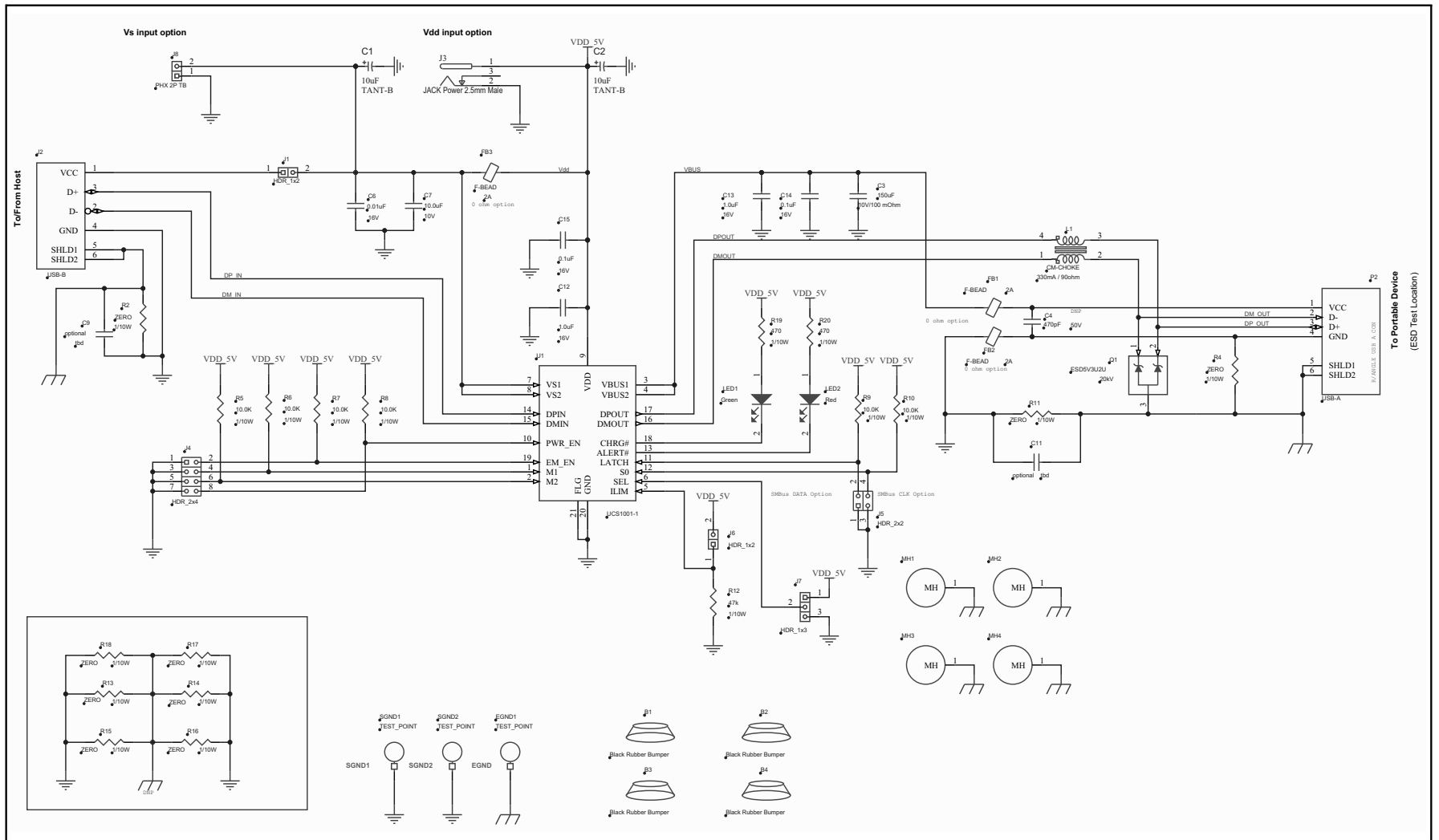

## A.3 BOARD – TOP SILK

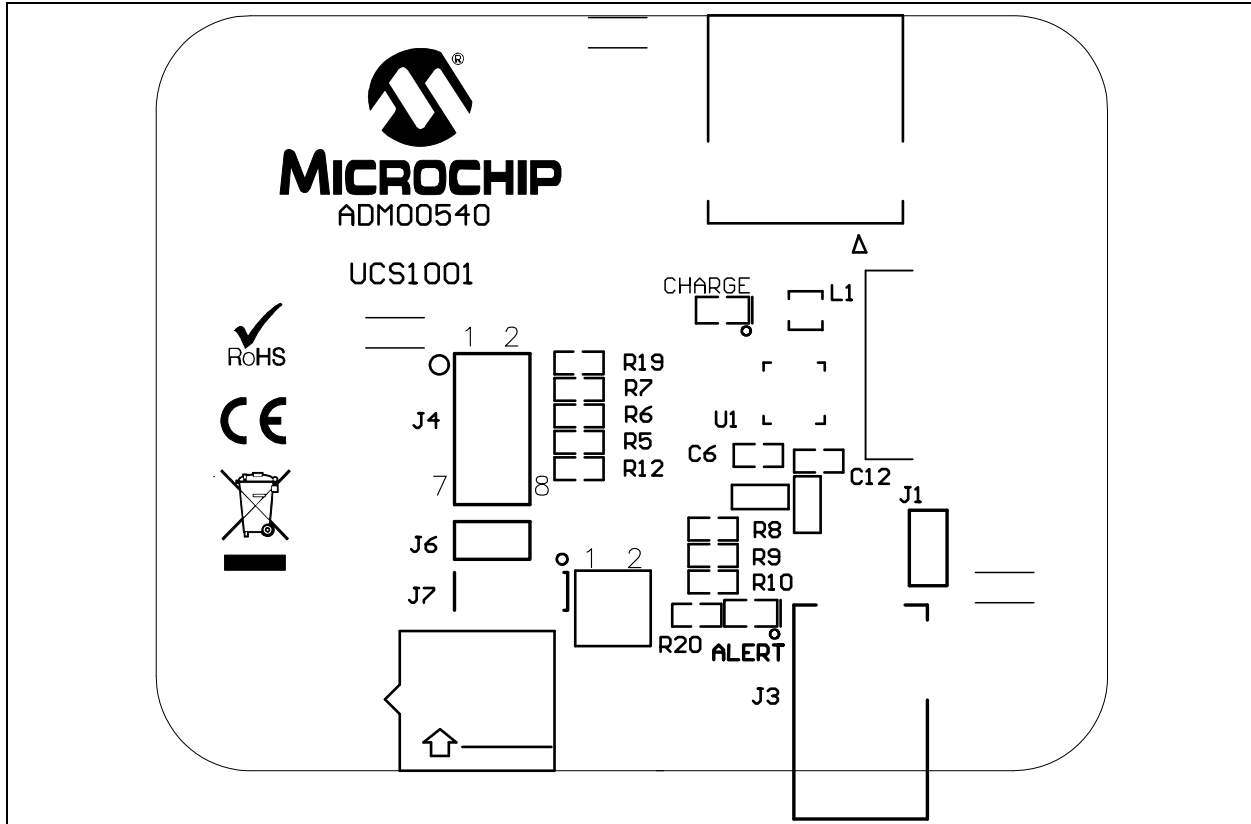

## A.4 BOARD – TOP SILK AND PADS

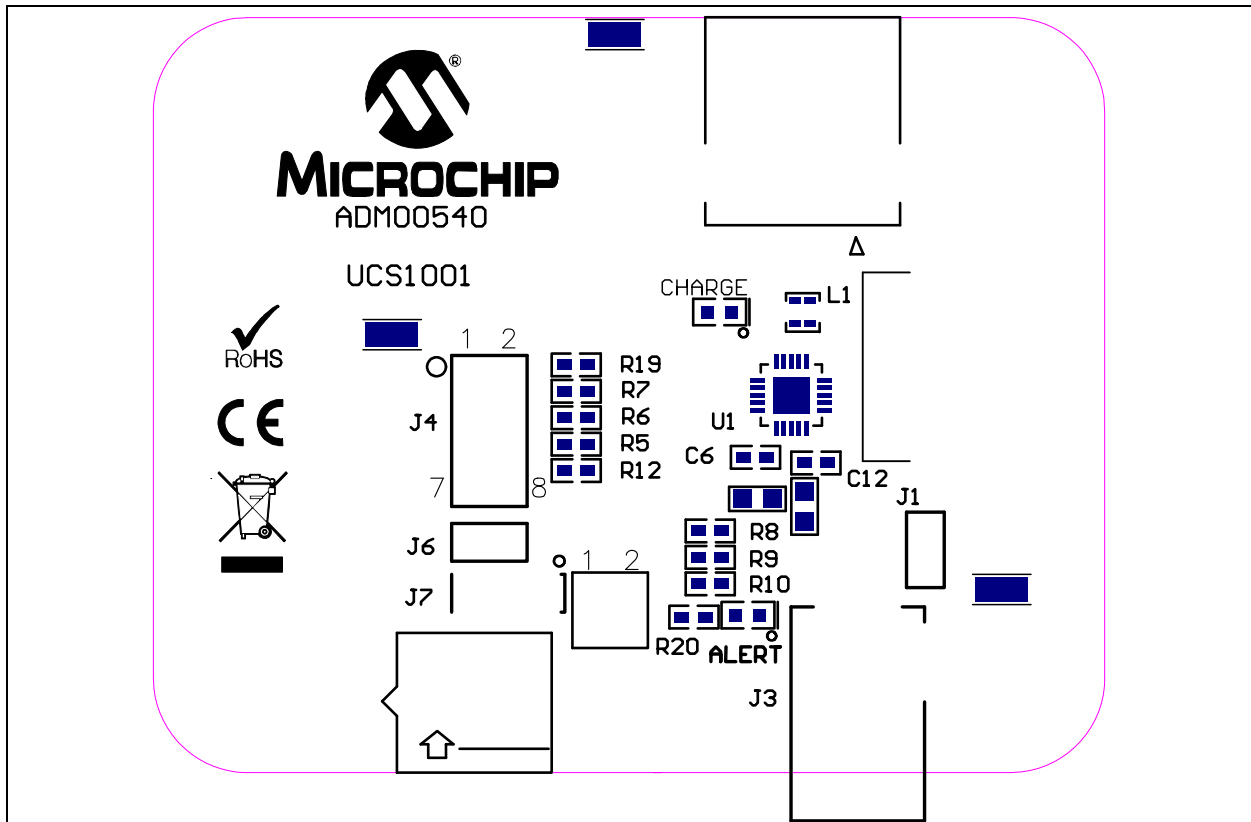

# UCS1001-3 Evaluation Board User's Guide

## A.5 BOARD – TOP SILK AND COPPER

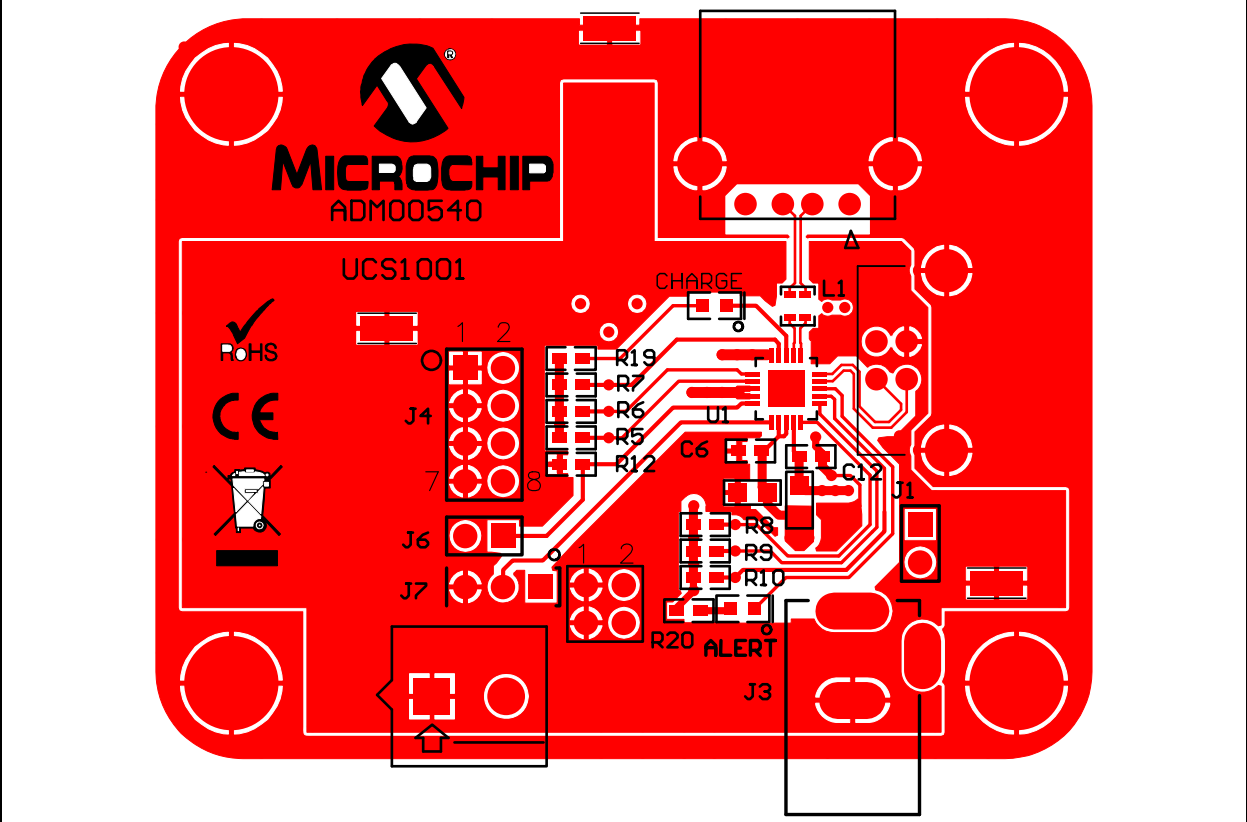

## A.6 BOARD – TOP COPPER

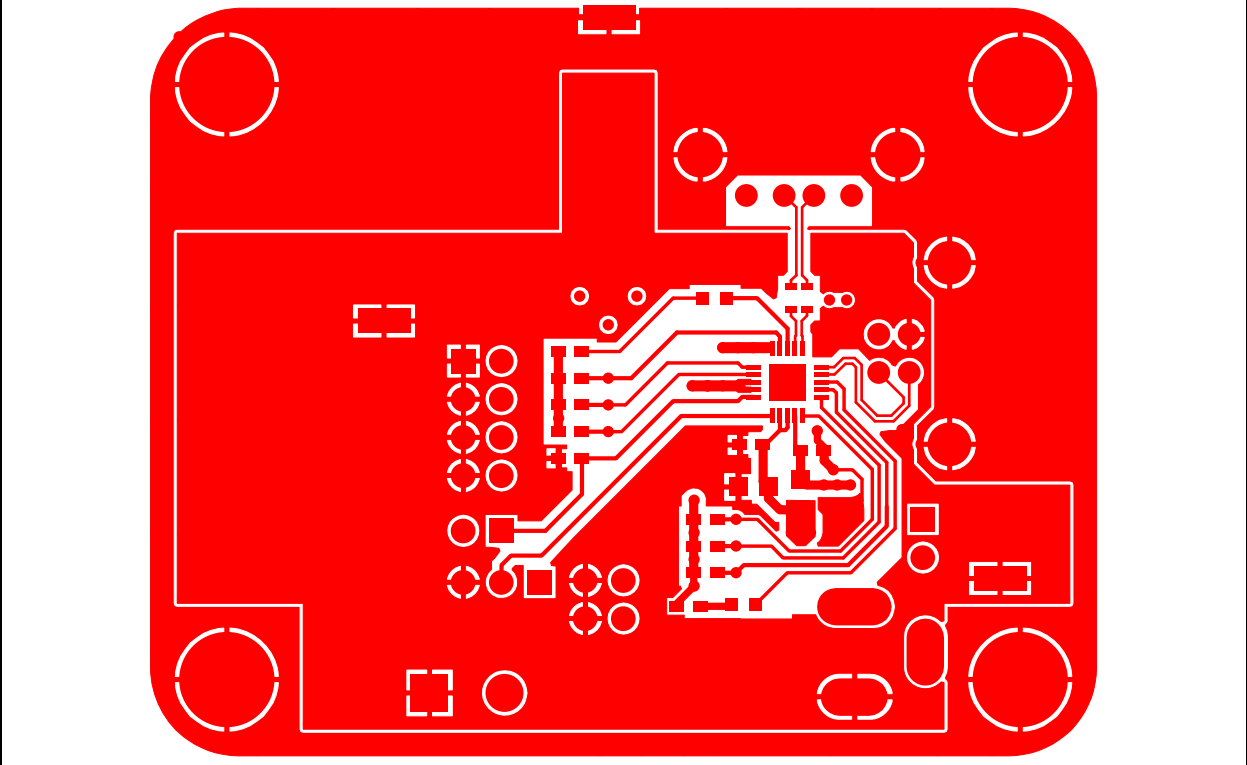

## A.7 BOARD – BOTTOM COPPER

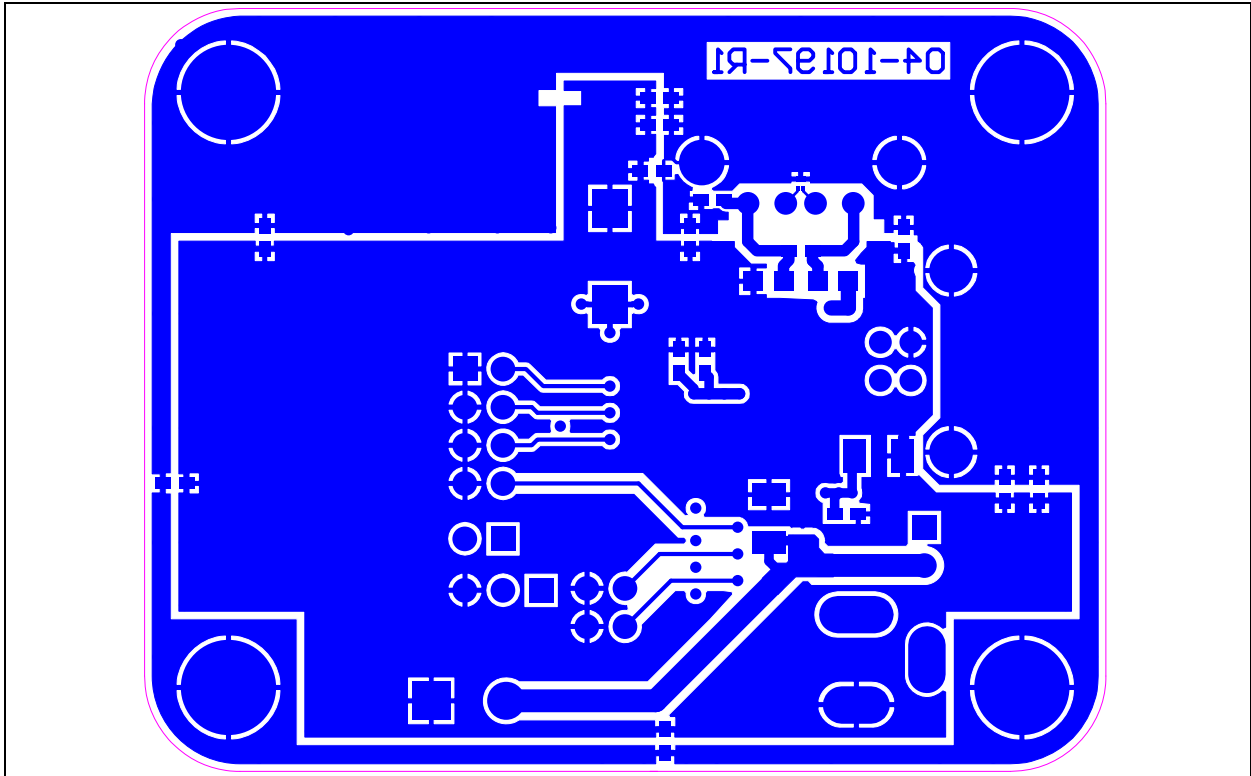

## A.8 BOARD – BOTTOM SILK AND COPPER

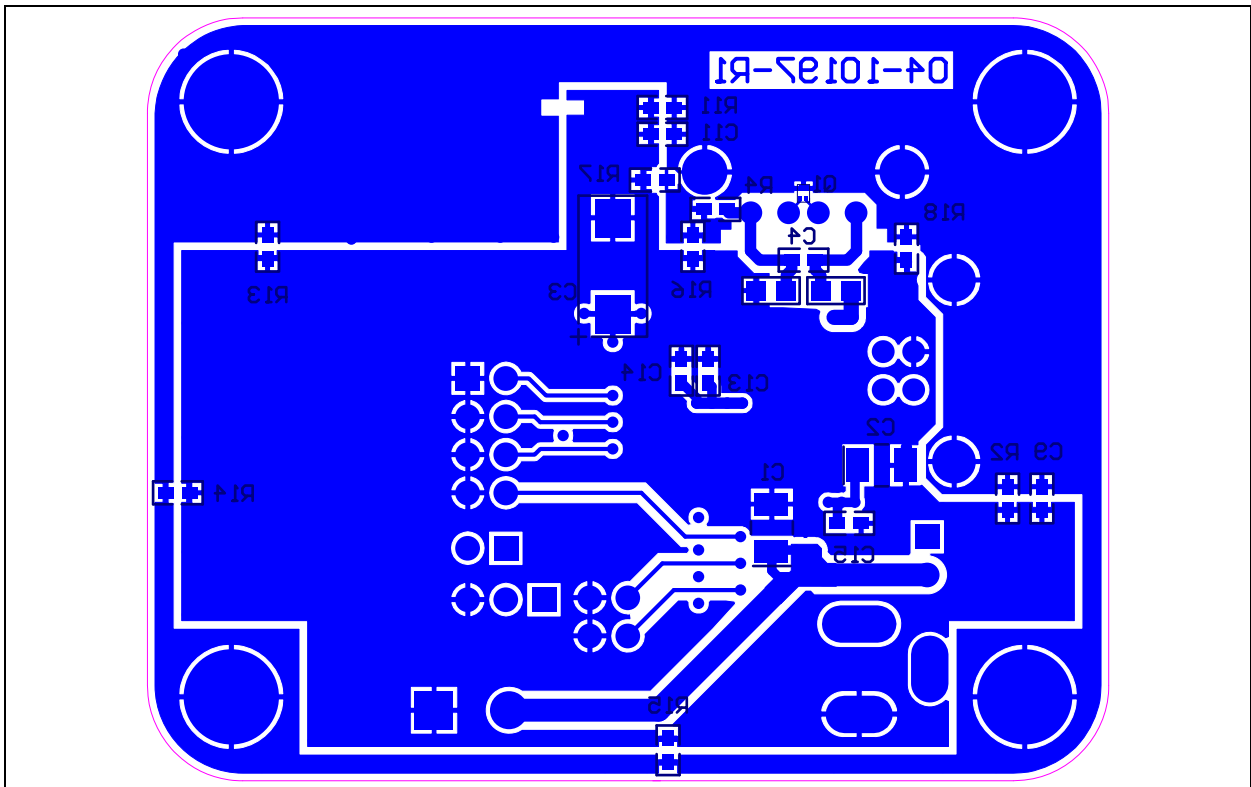

# UCS1001-3 Evaluation Board User's Guide

## A.9 BOARD – BOTTOM SILK AND PADS

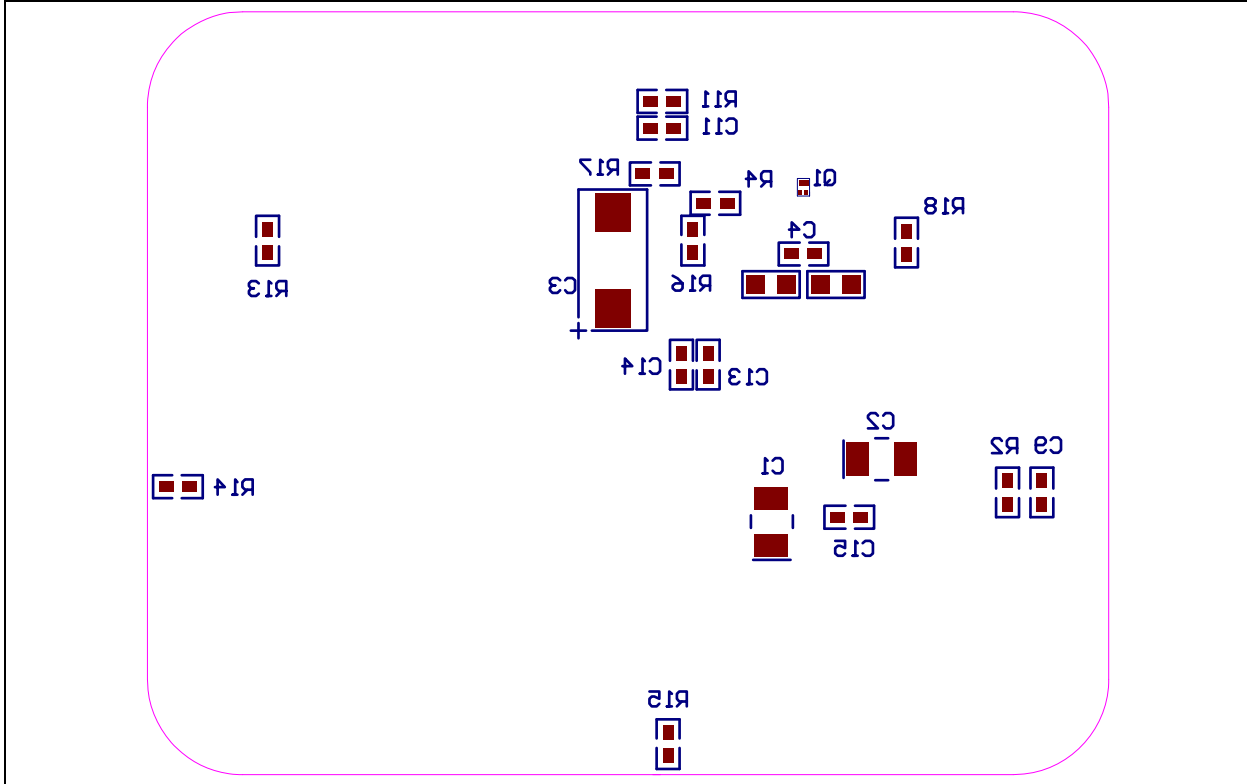

## A.10 BOARD – BOTTOM SILK

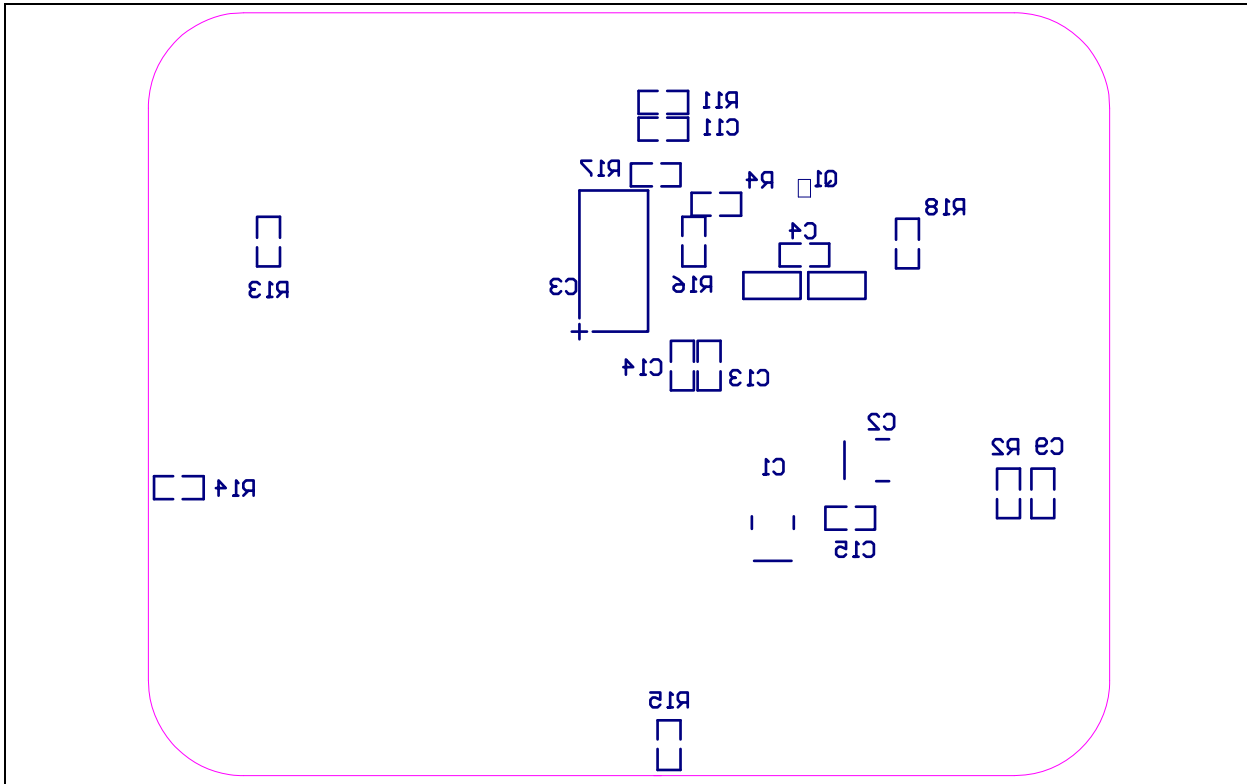



**Appendix B. Bill of Materials (BOM)**

**TABLE B-1: BILL OF MATERIALS (BOM)**

Qty.	Designator	Description	Manufacturer	Part Number
2	C1, C2	Cap. tant. 10 µF 20V 10% 1210	AVX Corporation	TAJB106K020RNJ
1	C3	Cap. tant. 150 µF 10V 10% 2917	AVX Corporation	TPSD157K010R0100
1	C4	Cap. ceramic 470 PF 50V 10% X7R 0603	Murata Electronics®	GRM188R71H471KA01D
1	C6	Cap. ceramic 10000 PF 50V 10% X7R 0603	Yageo Corporation	CC0603KRX7R9BB103
1	C7	Cap. ceramic 10 µF 10V 10% X7R 0805	Murata Electronics	GRM21BR71A106KE51
0	C9, C11	<b>DO NOT POPULATE</b>	—	—
2	C12, C13	Cap. ceramic 1 µF 16V 10% X5R 0603	Yageo Corporation	CC0603KRX5R7BB105
2	C14, C15	Cap. ceramic 0.1 µF 16V 10% X7R 0603	Yageo Corporation	CC0603KRX7R7BB104
3	EGND1, SGND1, SGND2	PC test point miniature SMT	Keystone Electronics Corp.	5015
3	FB1, FB2, FB3	Res. 0.0 OHM 1/8W jump. 0805 SMD	Panasonic® - ECG	ERJ-6GEY0R00V
2	J1, J6	Conn. header 2 pos. .100 vert. tin	FCI	77311-118-02LF
1	J2	Conn. USB recept. R/A type B 4 pos.	TE Connectivity, Ltd.	292304-1
1	J3	Conn. power jack male 2.5 MM clsd.	CUI Inc.	PJ-002B
1	J4	Conn. header 8 pos. 2 x 4 .100 str. 30 gold	FCI	68602-108HLF
1	J5	Conn. header 4 pos. .100" dual gold	FCI	68602-204HLF
1	J7	Conn. header 3 pos. .100 vert. tin	Molex®	0022284030
1	J8	Conn. term. block 2 pos. 5 MM PCB	Phoenix Contact GmbH & Co.	1729018
7	Jumper shunts	Shunt LP w/handle 2 pos. 30 gold	TE Connectivity, Ltd.	881545-2
1	L1	Choke common mode 90 OHM 0805	Murata Electronics	DLW21HN900SQ2L
1	LED1	LED pure green 0603 SMD	Stanley Electric Co., Ltd.	BG1111C-TR
1	LED2	LED red clear 0603 SMD	Lite-On® Technology Corp.	LTST-C190CKT
1	P2	Conn. rcpt. USB type A R/A PCB	FCI	87520-0010BLF
0	PCB	Printed Circuit Board - UCS1001-3 Evaluation Board	—	104-00540
1	Q1	Diode ESD array 5.3V TSLP-3-7	Infineon Technologies AG	ESD5V3U2U-03LRH E6327
8	R2, R11, R13, R14, R15, R16, R17, R18	Res. 0.0 ohm 1/10 W jump. 0603 SMD	Yageo Corporation	RC0603JR-070RL
1	R4	Res. 0.0 ohm 1/10W jump. 0603 SMD	Panasonic - ECG	ERJ-3GEY0R00V

**Note 1:** The components listed in this Bill of Materials are representative of the PCB assembly. The released BOM used in manufacturing uses all RoHS-compliant components.

# UCS1001-3 Evaluation Board User's Guide

**TABLE B-1: BILL OF MATERIALS (BOM) (CONTINUED)**

Qty.	Designator	Description	Manufacturer	Part Number
6	R5, R6, R7, R8, R9, R10	Res. 10.0K ohm 1/10W 1% 0603 SMD	Yageo Corporation	RC0603FR-0710KL
1	R12	Res. 47K ohm 1/10W 1% 0603	Stackpole Electronics, Inc.	RMCF0603FT47K0
2	R19, R20	Res. 470 ohm 1/10W 5% 0603 SMD	Yageo Corporation	RC0603JR-07470RL
1	U1	UCS1001-3 – USB Port Power Controller with Charger Emulation, 20LD QFN	Microchip Technology Inc.	<b>UCS1001-3-BP</b>

**Note 1:** The components listed in this Bill of Materials are representative of the PCB assembly. The released BOM used in manufacturing uses all RoHS-compliant components.

**TABLE B-2: BILL OF MATERIALS – PARTS ADDED TO THE PACKAGE**

Qty.	Designator	Description	Manufacturer	Part Number
4	B1, B2, B3, B4	Bumpon cylindrical .312 x .210 blk.	3M	SJ61A11
1	5V transformer	Adapter wall R-series 20W 5V	Phihong USA Inc.	PSAA20R-050
1	AC plug	Adapter wall R-series clip US	Phihong USA Inc.	RPA

# Bill of Materials (BOM)

---

---

NOTES:



# MICROCHIP

## Worldwide Sales and Service

### AMERICAS

**Corporate Office**  
2355 West Chandler Blvd.  
Chandler, AZ 85224-6199  
Tel: 480-792-7200  
Fax: 480-792-7277  
Technical Support:  
<http://www.microchip.com/support>  
Web Address:  
[www.microchip.com](http://www.microchip.com)

**Atlanta**  
Duluth, GA  
Tel: 678-957-9614  
Fax: 678-957-1455

**Austin, TX**  
Tel: 512-257-3370

**Boston**  
Westborough, MA  
Tel: 774-760-0087  
Fax: 774-760-0088

**Chicago**  
Itasca, IL  
Tel: 630-285-0071  
Fax: 630-285-0075

**Cleveland**  
Independence, OH  
Tel: 216-447-0464  
Fax: 216-447-0643

**Dallas**  
Addison, TX  
Tel: 972-818-7423  
Fax: 972-818-2924

**Detroit**  
Novi, MI  
Tel: 248-848-4000

**Houston, TX**  
Tel: 281-894-5983

**Indianapolis**  
Noblesville, IN  
Tel: 317-773-8323  
Fax: 317-773-5453

**Los Angeles**  
Mission Viejo, CA  
Tel: 949-462-9523  
Fax: 949-462-9608

**New York, NY**  
Tel: 631-435-6000

**San Jose, CA**  
Tel: 408-735-9110

**Canada - Toronto**  
Tel: 905-673-0699  
Fax: 905-673-6509

### ASIA/PACIFIC

**Asia Pacific Office**  
Suites 3707-14, 37th Floor  
Tower 6, The Gateway  
Harbour City, Kowloon  
Hong Kong  
Tel: 852-2401-1200  
Fax: 852-2401-3431

**Australia - Sydney**  
Tel: 61-2-9868-6733  
Fax: 61-2-9868-6755

**China - Beijing**  
Tel: 86-10-8569-7000  
Fax: 86-10-8528-2104

**China - Chengdu**  
Tel: 86-28-8665-5511  
Fax: 86-28-8665-7889

**China - Chongqing**  
Tel: 86-23-8980-9588  
Fax: 86-23-8980-9500

**China - Hangzhou**  
Tel: 86-571-2819-3187  
Fax: 86-571-2819-3189

**China - Hong Kong SAR**  
Tel: 852-2943-5100  
Fax: 852-2401-3431

**China - Nanjing**  
Tel: 86-25-8473-2460  
Fax: 86-25-8473-2470

**China - Qingdao**  
Tel: 86-532-8502-7355  
Fax: 86-532-8502-7205

**China - Shanghai**  
Tel: 86-21-5407-5533  
Fax: 86-21-5407-5066

**China - Shenyang**  
Tel: 86-24-2334-2829  
Fax: 86-24-2334-2393

**China - Shenzhen**  
Tel: 86-755-8864-2200  
Fax: 86-755-8203-1760

**China - Wuhan**  
Tel: 86-27-5980-5300  
Fax: 86-27-5980-5118

**China - Xian**  
Tel: 86-29-8833-7252  
Fax: 86-29-8833-7256

**China - Xiamen**  
Tel: 86-592-2388138  
Fax: 86-592-2388130

**China - Zhuhai**  
Tel: 86-756-3210040  
Fax: 86-756-3210049

### ASIA/PACIFIC

**India - Bangalore**  
Tel: 91-80-3090-4444  
Fax: 91-80-3090-4123

**India - New Delhi**  
Tel: 91-11-4160-8631  
Fax: 91-11-4160-8632

**India - Pune**  
Tel: 91-20-3019-1500

**Japan - Osaka**  
Tel: 81-6-6152-7160  
Fax: 81-6-6152-9310

**Japan - Tokyo**  
Tel: 81-3-6880-3770  
Fax: 81-3-6880-3771

**Korea - Daegu**  
Tel: 82-53-744-4301  
Fax: 82-53-744-4302

**Korea - Seoul**  
Tel: 82-2-554-7200  
Fax: 82-2-558-5932 or  
82-2-558-5934

**Malaysia - Kuala Lumpur**  
Tel: 60-3-6201-9857  
Fax: 60-3-6201-9859

**Malaysia - Penang**  
Tel: 60-4-227-8870  
Fax: 60-4-227-4068

**Philippines - Manila**  
Tel: 63-2-634-9065  
Fax: 63-2-634-9069

**Singapore**  
Tel: 65-6334-8870  
Fax: 65-6334-8850

**Taiwan - Hsin Chu**  
Tel: 886-3-5778-366  
Fax: 886-3-5770-955

**Taiwan - Kaohsiung**  
Tel: 886-7-213-7830

**Taiwan - Taipei**  
Tel: 886-2-2508-8600  
Fax: 886-2-2508-0102

**Thailand - Bangkok**  
Tel: 66-2-694-1351  
Fax: 66-2-694-1350

### EUROPE

**Austria - Wels**  
Tel: 43-7242-2244-39  
Fax: 43-7242-2244-393

**Denmark - Copenhagen**  
Tel: 45-4450-2828  
Fax: 45-4485-2829

**France - Paris**  
Tel: 33-1-69-53-63-20  
Fax: 33-1-69-30-90-79

**Germany - Dusseldorf**  
Tel: 49-2129-3766400

**Germany - Munich**  
Tel: 49-89-627-144-0  
Fax: 49-89-627-144-44

**Germany - Pforzheim**  
Tel: 49-7231-424750

**Italy - Milan**  
Tel: 39-0331-742611  
Fax: 39-0331-466781

**Italy - Venice**  
Tel: 39-049-7625286

**Netherlands - Drunen**  
Tel: 31-416-690399  
Fax: 31-416-690340

**Poland - Warsaw**  
Tel: 48-22-3325737

**Spain - Madrid**  
Tel: 34-91-708-08-90  
Fax: 34-91-708-08-91

**Sweden - Stockholm**  
Tel: 46-8-5090-4654

**UK - Wokingham**  
Tel: 44-118-921-5800  
Fax: 44-118-921-5820

10/28/13