

**AUTOMOTIVE GRADE 1.225V AND ADJUSTABLE PRECISION REFERENCE**

**Description**

The LM4041 is a bandgap circuit designed to achieve a precision micro-power voltage reference of 1.225 V; it is also available in an adjustable version. The device is available in the small outline SOT23 surface mount package which is ideal for applications where space saving is important.

The fixed output version is available in 0.5% C grade and 1% D grade while the adjustable is only available in D grade. Excellent performance is maintained over the 60µA to 12mA operating current range with a typical temperature coefficient of only 20ppm/°C. The device has been designed to be highly tolerant of capacitive loads so maintaining excellent stability.

This device offers a pin for pin compatible alternative to the LM4041 voltage reference in both adjustable and 1.225V output variants for automotive applications.

The LM4041Q has been qualified to AEC-Q100 Grade 1 and is Automotive Grade supporting PPAPs.

**Pin Assignments**

**LM4041\_QF (SOT23)**

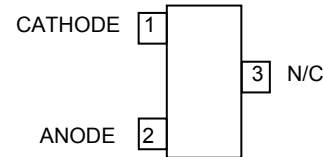

Pin 3 must left floating or connected to pin 2.

**LM4041\_ADJQF....(SOT23)**

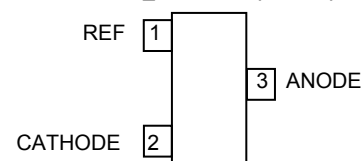

**Features**

- No output capacitor required
- Output voltage tolerance
  - LM4041CQ: ±0.5% at +25°C
  - LM4041DQ: ±1.0% at +25°C
- Low output noise:
  - 10Hz to 10kHz 20µVrms
- Wide operating current range: 60µA to 12mA
- Extended temperature range: -40°C to +125°C
- Low temperature coefficient: 100ppm/°C (max)
- Green Molding in small package SOT23
- **Totally Lead-Free & Fully RoHS Compliant (Notes 1 & 2)**
- **Halogen and Antimony Free. "Green" Device (Note 3)**
- Automotive Grade
- **Qualified to AEC-Q100 Standards for High Reliability**
- **PPAP Capable (Note 4)**

**Applications**

- Battery powered equipment
- Precision power supplies

Notes:

1. No purposely added lead. Fully EU Directive 2002/95/EC (RoHS) & 2011/65/EU (RoHS 2) compliant.
2. See [http://www.diodes.com/quality/lead\\_free.html](http://www.diodes.com/quality/lead_free.html) for more information about Diodes Incorporated's definitions of Halogen- and Antimony-free, "Green" and Lead-free.
3. Halogen- and Antimony-free "Green" products are defined as those which contain <900ppm bromine, <900ppm chlorine (<1500ppm total Br + Cl) and <1000ppm antimony compounds.
4. Automotive products are AEC-Q100 qualified and are PPAP capable. Automotive, AEC-Q100 and standard products are electrically and thermally the same, except where specified. For more information, please refer to [http://www.diodes.com/quality/product\\_compliance\\_definitions/](http://www.diodes.com/quality/product_compliance_definitions/).

## Absolute Maximum Ratings

Description		Rating	Unit
Continuous Reverse Current ( $I_R$ )		20	mA
Continuous Forward Current ( $I_F$ )		10	mA
Maximum Output Voltage (LM4041_ADJ)		15	V
Junction Temperature		-40 to +155	°C
Storage Temperature		-55 to +150	°C
<b>ESD Ratings</b>			
HBM	Human Body Model	4000	V
MM	Machine Model	200	V
CDM	Charged Device Model	TBD	V

Caution: Stresses greater than the 'Absolute Maximum Ratings' specified above, may cause permanent damage to the device. These are stress ratings only; functional operation of the device at conditions between maximum recommended operating conditions and absolute maximum ratings is not implied. Device reliability may be affected by exposure to absolute maximum rating conditions for extended periods of time.

(Semiconductor devices are ESD sensitive and may be damaged by exposure to ESD events. Suitable ESD precautions should be taken when handling and transporting these devices.)

Unless otherwise stated voltages specified are relative to the ANODE pin.

## Package Thermal Data

Package	$\theta_{JA}$	$P_{DIS}$ $T_A = +25^\circ\text{C}, T_J = +150^\circ\text{C}$
SOT23	380°C/W	330mW

## Recommended Operating Conditions

Parameter	Min	Max	Units
Reverse Current	0.06	12	mA
Output Voltage Range	1.24	10	V
Operating Ambient Temperature Range	-40	+125	°C

## Electrical Characteristics

### LM4041\_Q (Fixed 1.225V)

Electrical characteristics over recommended operating conditions,  $T_A = +25^\circ\text{C}$ , unless otherwise stated,  $I_{RMIN} \leq I_R \leq 12\text{mA}$ ,  $V_{REF} \leq V_{OUT} \leq 10\text{V}$ . LM4041CQ and LM4041DQ have initial tolerances of 0.5% and 1% respectively.

Symbol	Parameter	Conditions		Typ	LM4041C Limits	LM4041D Limits	Units
		—	$T_A$				
$V_{REF}$	Reverse Breakdown Voltage	$I_R = 100\mu\text{A}$	$+25^\circ\text{C}$	1.225	—	—	V
	Reverse Breakdown Voltage Tolerance		$+25^\circ\text{C}$	—	$\pm 6$	$\pm 12$	mV
			$-40^\circ\text{C}$ to $+85^\circ\text{C}$	—	$\pm 14$	$\pm 24$	
			$-40^\circ\text{C}$ to $+125^\circ\text{C}$	—	$\pm 18.4$	$\pm 31$	
$I_{RMIN}$	Minimum Operating Current	—	$+25^\circ\text{C}$	45	60	65	$\mu\text{A}$
			$-40^\circ\text{C}$ to $+85^\circ\text{C}$		65	70	
			$-40^\circ\text{C}$ to $+125^\circ\text{C}$		68	73	
$\Delta V_R/\Delta T$	Average Reverse Breakdown Voltage Temperature Coefficient	$I_R = 10\text{mA}$	$-40^\circ\text{C}$ to $+125^\circ\text{C}$	$\pm 20$	—	—	ppm/ $^\circ\text{C}$
		$I_R = 1\text{mA}$ ,		$\pm 15$	$\pm 100$	$\pm 150$	
		$I_R = 100\mu\text{A}$		$\pm 15$	—	—	
$\Delta V_R/\Delta I_R$	Reverse Breakdown Change With Current	$I_{RMIN} < I_R < 1\text{mA}$	$+25^\circ\text{C}$	0.7	1.5	2.0	mV
			$-40^\circ\text{C}$ to $+85^\circ\text{C}$		2.0	2.5	
			$-40^\circ\text{C}$ to $+125^\circ\text{C}$		2.0	2.5	
		$1\text{mA} < I_R < 12\text{mA}$	$+25^\circ\text{C}$	2.5	6.0	8.0	
			$-40^\circ\text{C}$ to $+85^\circ\text{C}$		8.0	10.0	
			$-40^\circ\text{C}$ to $+125^\circ\text{C}$		8.0	10.0	
$Z_R$	Dynamic Output Impedance	$I_R = 1\text{mA}$ , $f = 120\text{Hz}$ , $I_{AC} = 0.1I_R$		0.5	1.5	2.0	$\Omega$
$e_n$	Noise Voltage	$I_R = 100\mu\text{A}$ , $10\text{Hz} < f < 10\text{kHz}$		20	—	—	$\mu\text{V}_{RMS}$
$\Delta V_R$	Long Term Stability (Non cumulative)	$t = 1000\text{Hrs}$ , $I_R = 100\mu\text{A}$		120	—	—	ppm

### LM4041DADJQ (Adjustable)

Electrical characteristics over recommended operating conditions,  $T_A = +25^\circ\text{C}$ ,  $I_{RMIN} \leq I_R \leq 12\text{mA}$ ,  $V_{REF} \leq V_{OUT} \leq 10\text{V}$  unless otherwise stated. The grade D designates initial reference voltage tolerance of  $\pm 1\%$  and is measured at an output/cathode voltage of 5V.

Symbol	Parameter	Conditions		Typ	LM4041D Limits	Units
		—	$T_A$			
$V_{REF}$	Reverse Breakdown Voltage	$I_R = 100\mu\text{A}$ , $V_{KA} = 5\text{V}$	$+25^\circ\text{C}$	1.233	—	V
	Reverse Breakdown Voltage Tolerance		$+25^\circ\text{C}$	—	$\pm 12$	mV
			$-40^\circ\text{C}$ to $+85^\circ\text{C}$	—	$\pm 24$	
			$-40^\circ\text{C}$ to $+125^\circ\text{C}$	—	$\pm 30$	
$I_{RMIN}$	Minimum Operating Current	—	$+25^\circ\text{C}$	45	65	$\mu\text{A}$
			$-40^\circ\text{C}$ to $+85^\circ\text{C}$		70	
			$-40^\circ\text{C}$ to $+125^\circ\text{C}$		73	
$\Delta V_R/\Delta T$	Average Reverse Breakdown Voltage Temperature Coefficient	$I_R = 10\text{mA}$	$-40^\circ\text{C}$ to $+125^\circ\text{C}$	$\pm 20$	—	ppm/ $^\circ\text{C}$
		$I_R = 1\text{mA}$ ,		$\pm 15$	$\pm 150$	
		$I_R = 100\mu\text{A}$		$\pm 15$	—	
$\Delta V_R/\Delta V_K$	Reference voltage change with cathode voltage change	$I_R = 1\text{mA}$	$+25^\circ\text{C}$	-1.55	-2.5	mV/V
			$-40^\circ\text{C}$ to $+85^\circ\text{C}$		-3.0	
			$-40^\circ\text{C}$ to $+125^\circ\text{C}$		-4.0	
$I_{REF}$	Reference input current	—	$+25^\circ\text{C}$	60	150	nA
			$-40^\circ\text{C}$ to $+85^\circ\text{C}$		200	
			$-40^\circ\text{C}$ to $+125^\circ\text{C}$		200	
$\Delta V_R/\Delta I_R$	Reverse Breakdown Change With Current	$I_{RMIN} < I_R < 1\text{mA}$ $V_{OUT} > 1.6\text{V}$	$+25^\circ\text{C}$	0.7	2.0	mV
			$-40^\circ\text{C}$ to $+85^\circ\text{C}$		2.5	
			$-40^\circ\text{C}$ to $+125^\circ\text{C}$		2.5	
		$1\text{mA} < I_R < 12\text{mA}$ $V_{OUT} > 1.6\text{V}$	$+25^\circ\text{C}$	2	6.0	
			$-40^\circ\text{C}$ to $+85^\circ\text{C}$		8.0	
			$-40^\circ\text{C}$ to $+125^\circ\text{C}$		10.0	
$Z_R$	Dynamic Output Impedance	$I_R = 1\text{mA}$ , $f = 120\text{Hz}$ $I_{AC} = 0.1I_R$	$V_{KA} = V_{REF}$	0.5	—	$\Omega$
			$V_{KA} = 10\text{V}$	2	—	$\Omega$
$e_n$	Noise Voltage	$I_R = 100\mu\text{A}$ , $10\text{Hz} < f < 10\text{kHz}$		20	—	$\mu\text{V}_{RMS}$
$\Delta V_R$	Long Term Stability (Non cumulative)	$t = 1000\text{Hrs}$ , $I_R = 100\mu\text{A}$		120	—	ppm

**Typical Characteristics LM4041Q - 1.225**

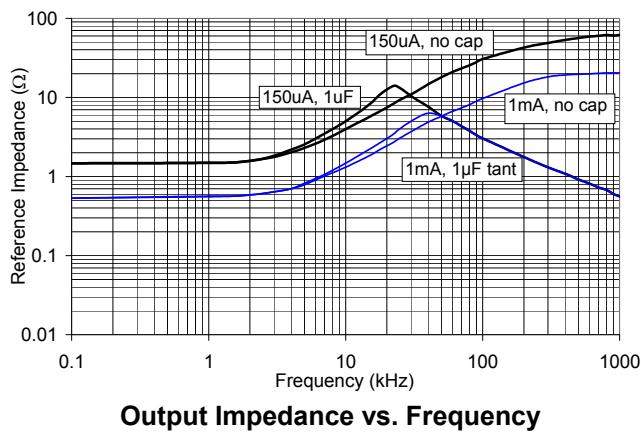
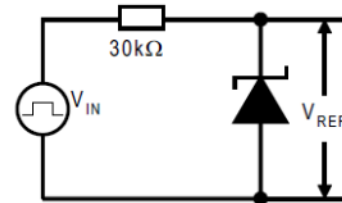
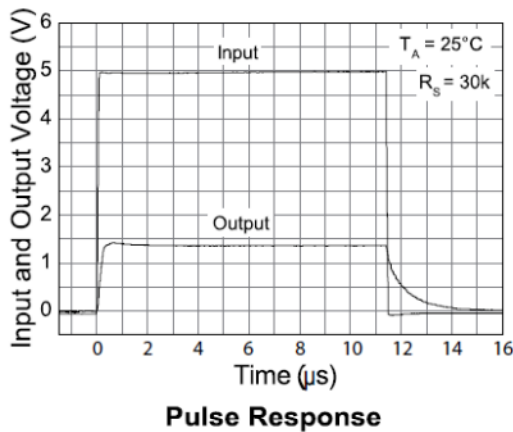
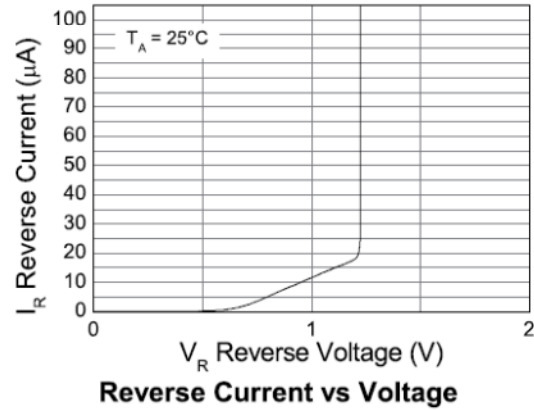
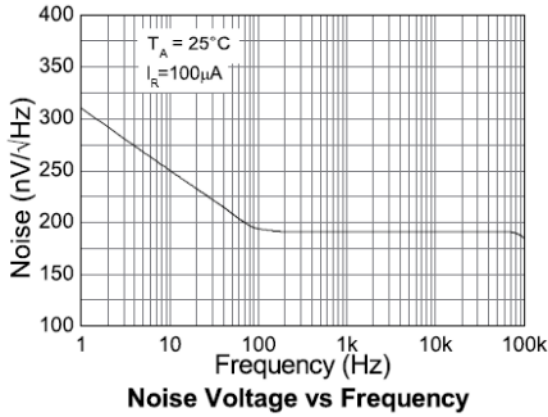

## Application Information

The LM4041Q comes in two variants:

- LM4041\_Q with fixed 1.225V output
- LM4041DADJQ with variable output voltage.

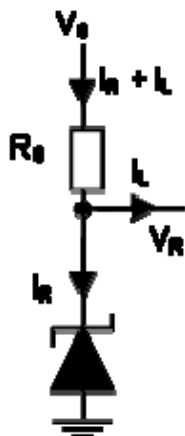

Figure 1

In a conventional shunt reference (2-terminal, fixed output device) application (Figure 1), an external series resistor ( $R_S$ ) is connected between the supply voltage,  $V_S$ , and the LM4041Q.

$R_S$  determines the current that flows through the load ( $I_L$ ) and the LM4041Q ( $I_R$ ). Since load current and supply voltage may vary,  $R_S$  should be small enough to supply at least the minimum acceptable  $I_R$  to the LM4041Q even when the supply voltage is at its minimum and the load current is at its maximum value. When the supply voltage is at its maximum and  $I_L$  is at its minimum,  $R_S$  should be large enough so that the current flowing through the LM4041Q is less than 12 mA.

$R_S$  is determined by the supply voltage, ( $V_S$ ), the load and operating current, ( $I_L$  and  $I_Q$ ), and the LM4041Q's reverse breakdown voltage,  $V_R$ .

$$R_S = \frac{V_S - V_R}{I_L + I_R}$$

For the adjustable device 3-terminals are used

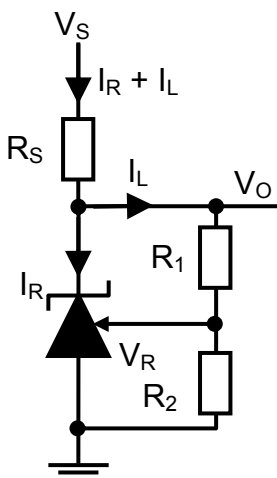

Figure 2

The LM4041Q-ADJ's output voltage can be adjusted to any value in the range of 1.24V through 10V. The output voltage is set by the ratio of two external feedback resistors as shown in Figure 2 and the internal reference voltage ( $V_R$ ).

The output voltage is found using the equation:

$$V_O = V_R \times \left( 1 + \frac{R_2}{R_1} \right)$$

## Printed Circuit Board Layout Considerations

LM4041Q with fixed output voltage in the SOT23 package has the die attached to pin 3, which results in an electrical contact between pin 2 and pin 3.

Therefore, pin 3 of the SOT23 package must be left floating or connected to pin 2.

## Ordering Information

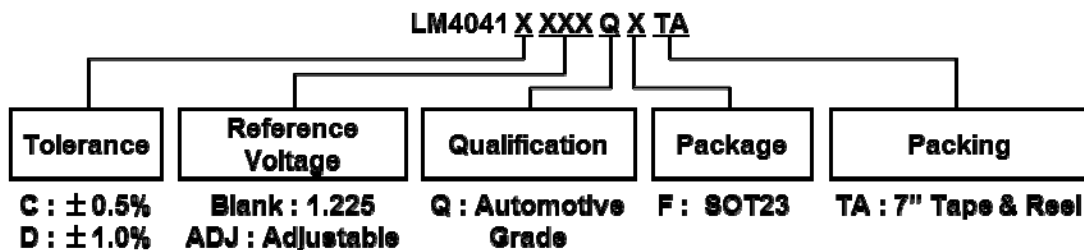

Order Code	+25°C Tol	Voltage (V)	Package (Note 5)	Package Code	Identification Code	Packing: 7" Tape and Reel			Qualification Grade (Note 6)
						Quantity	Tape width	Part Number Suffix	
LM4041CQFTA	0.5%	1.225	SOT23	F	R1C	3000	8mm	TA	Automotive Grade
LM4041DQFTA	1%	1.225	SOT23	F	R1D	3000	8mm	TA	Automotive Grade
LM4041DADJQFTA	1%	Adj	SOT23	F	RAD	3000	8mm	TA	Automotive Grade

- Note: 5. Pad layout as shown on Diodes Inc. suggested pad layout document AP02001, which can be found on our website at <http://www.diodes.com/datasheets/ap02001.pdf>
6. LM4041Q has been qualified to AEC-Q100 grade 1 and is classified as "Automotive Grade" supporting PPAP documentation. See LM4041 datasheet for commercial qualified versions.

## Marking Information

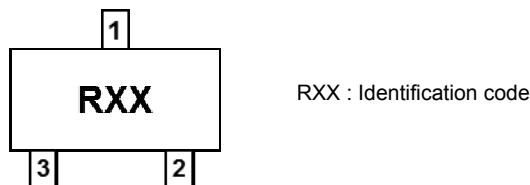

## Package Outline Information

Please see AP02001 at <http://www.diodes.com/datasheets/ap02002.pdf> for latest version

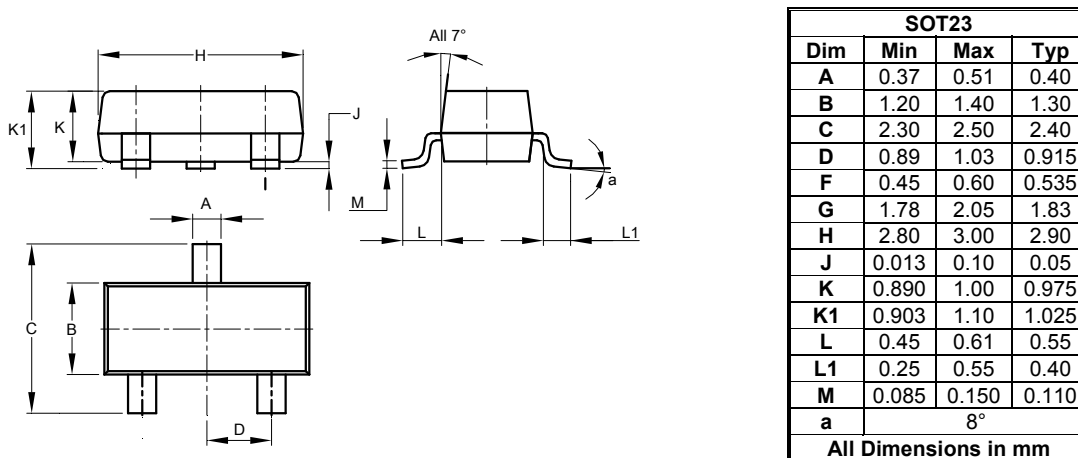

## Suggested Pad Layout

Please see AP02001 at <http://www.diodes.com/datasheets/ap02001.pdf> for latest version.

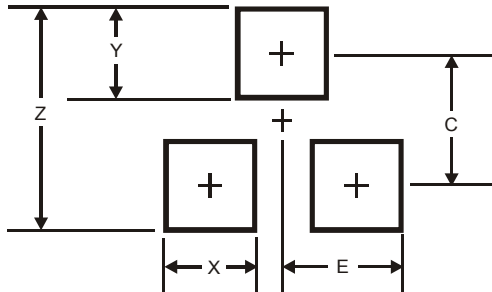

Dimensions	Value (in mm)
Z	2.9
X	0.8
Y	0.9
C	2.0
E	1.35

### IMPORTANT NOTICE

DIODES INCORPORATED MAKES NO WARRANTY OF ANY KIND, EXPRESS OR IMPLIED, WITH REGARDS TO THIS DOCUMENT, INCLUDING, BUT NOT LIMITED TO, THE IMPLIED WARRANTIES OF MERCHANTABILITY AND FITNESS FOR A PARTICULAR PURPOSE (AND THEIR EQUIVALENTS UNDER THE LAWS OF ANY JURISDICTION).

Diodes Incorporated and its subsidiaries reserve the right to make modifications, enhancements, improvements, corrections or other changes without further notice to this document and any product described herein. Diodes Incorporated does not assume any liability arising out of the application or use of this document or any product described herein; neither does Diodes Incorporated convey any license under its patent or trademark rights, nor the rights of others. Any Customer or user of this document or products described herein in such applications shall assume all risks of such use and will agree to hold Diodes Incorporated and all the companies whose products are represented on Diodes Incorporated website, harmless against all damages.

Diodes Incorporated does not warrant or accept any liability whatsoever in respect of any products purchased through unauthorized sales channel. Should Customers purchase or use Diodes Incorporated products for any unintended or unauthorized application, Customers shall indemnify and hold Diodes Incorporated and its representatives harmless against all claims, damages, expenses, and attorney fees arising out of, directly or indirectly, any claim of personal injury or death associated with such unintended or unauthorized application.

Products described herein may be covered by one or more United States, international or foreign patents pending. Product names and markings noted herein may also be covered by one or more United States, international or foreign trademarks.

This document is written in English but may be translated into multiple languages for reference. Only the English version of this document is the final and determinative format released by Diodes Incorporated.

### LIFE SUPPORT

Diodes Incorporated products are specifically not authorized for use as critical components in life support devices or systems without the express written approval of the Chief Executive Officer of Diodes Incorporated. As used herein:

A. Life support devices or systems are devices or systems which:

1. are intended to implant into the body, or
2. support or sustain life and whose failure to perform when properly used in accordance with instructions for use provided in the labeling can be reasonably expected to result in significant injury to the user.

B. A critical component is any component in a life support device or system whose failure to perform can be reasonably expected to cause the failure of the life support device or to affect its safety or effectiveness.

Customers represent that they have all necessary expertise in the safety and regulatory ramifications of their life support devices or systems, and acknowledge and agree that they are solely responsible for all legal, regulatory and safety-related requirements concerning their products and any use of Diodes Incorporated products in such safety-critical, life support devices or systems, notwithstanding any devices- or systems-related information or support that may be provided by Diodes Incorporated. Further, Customers must fully indemnify Diodes Incorporated and its representatives against any damages arising out of the use of Diodes Incorporated products in such safety-critical, life support devices or systems.

Copyright © 2014, Diodes Incorporated

[www.diodes.com](http://www.diodes.com)